

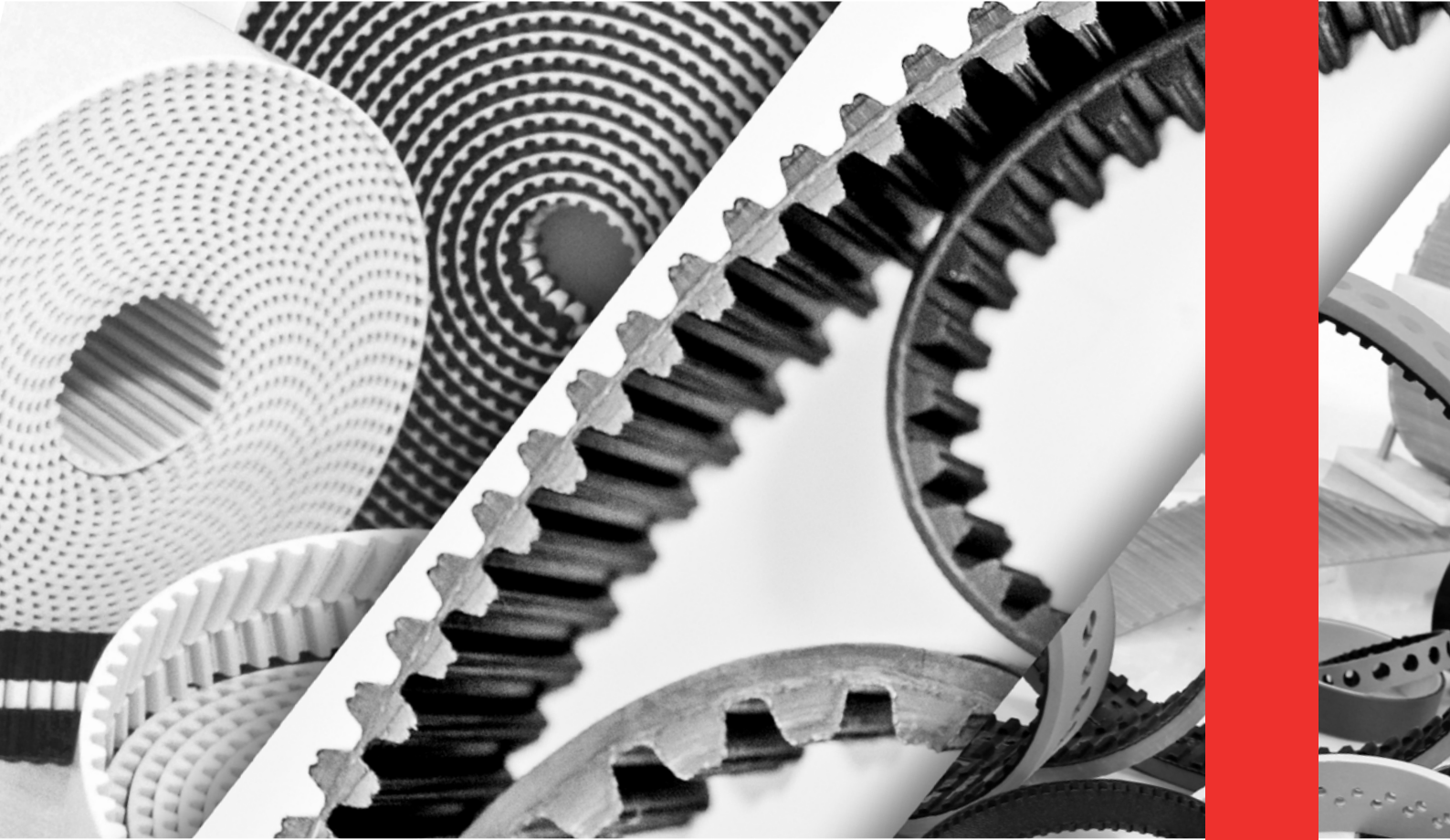

**MEGADYNE**



# ***CORPORATE OVERVIEW***

CORPORATE  
PRODUCT GUIDE

*EN*

# WELCOME TO **MEGADYNE**

Founded in 1957 and based in Mathi (Italy), Megadyne is a global manufacturer of rubber and urethane drive belts and associated components used in power transmission, product handling and linear positioning applications. Megadyne has grown from being a small family company to an international leader in its related fields.



- 9**  FACTORIES IN EUROPE, ASIA AND AMERICA
- +170**  COMMERCIAL LOCATIONS
- +2400**  EMPLOYEES
- 3**  MAIN HUBS, ONE PER REGION

As part of the Ammega Group, we share the same vision:

*WE ASPIRE TO BE THE LOCAL PARTNER OF CHOICE FOR SUSTAINABLE BELTING SOLUTIONS – AROUND THE GLOBE.*

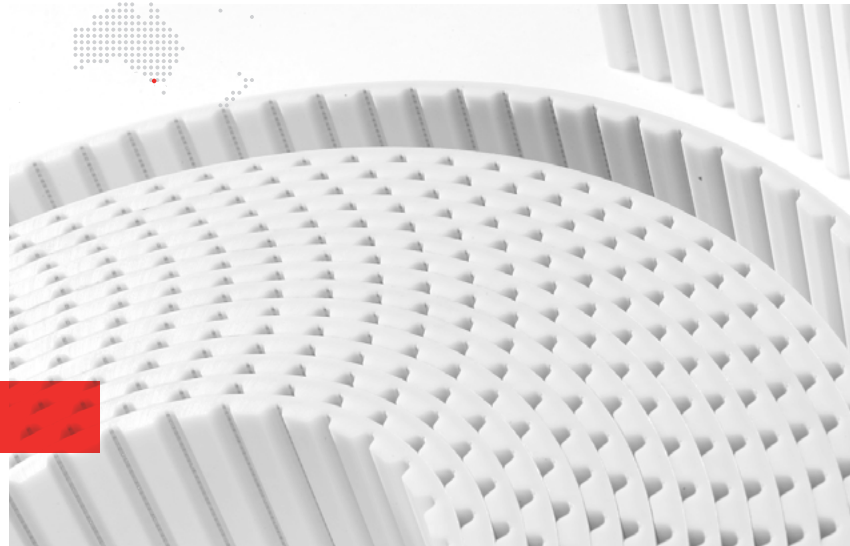

## OUR VALUES

After six decades of progressive expansion, organic development and strategic acquisitions, Megadyne remains committed to investing in best-in-class manufacturing, distribution and fabrication capabilities.

Thanks to our diversified Product Portfolio, we provide a full range of power transmission and product handling solutions for all industry segments.



### Entrepreneurship

We encourage entrepreneurial thinking and empower our people to take intelligent risks and make sound decisions.

### People Focus

Our carefully selected people, experts in their fields are our most valuable resource, working together as one company creating our unique advantage.

### Customer Centricity

We are customer-centric because we know that we succeed when our customers succeed and that customer satisfaction drives customer loyalty.

### Responsibility

We are part of a larger business community that we can help improve by working responsibly, by maintaining and increasing transparency and by acting ethically as good corporate citizens at all times.

### Agility

Speed is a key driver in our industry. We aim to respond quickly towards our customers, optimizing our delivery time and making fast decisions at all levels in our organization.

## INDUSTRIES SERVED

Megadyne partners with Original Equipment Manufacturers and Distributors worldwide to engineer solutions for the most demanding applications in many industrial markets:

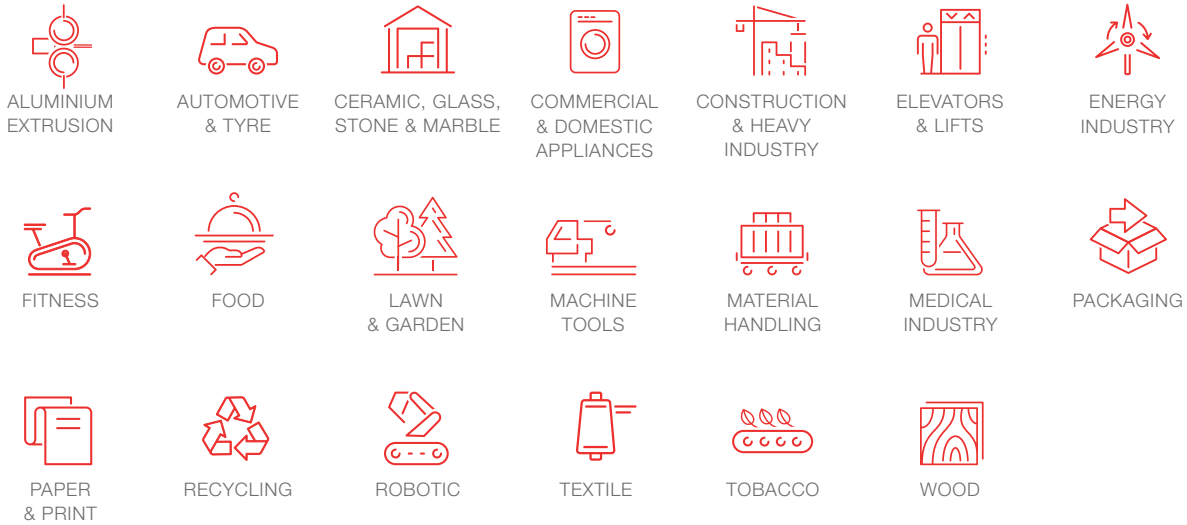





## E-COMMERCE AREA

Discover our e-commerce area reserved for our customers.

1. Search for information and download technical manuals
2. Check product availability and price
3. Request a quote
4. Place your order
5. Track shipment
6. Review order details and history
7. Update account information

## MAIN BENEFITS

-  **Available 24/7**  
Place your order or submit an enquiry anytime, anywhere, any device.
-  **Real time data**  
Access to current stock availability, pricing and delivery.
-  **Reduce errors and save time**  
Eliminate time consuming manual activities to place your order.
-  **Easily track order status and history**  
All order details are available at your fingertips - access current order details, order history and general account information.
-  **Access relevant product information**  
Discover new products, download product brochures and access additional product detail information.



NOT A CUSTOMER YET?  
**CONTACT US!**

# TIMING BELTS

## MEGADYNE MEGASYNC™

Rubber endless timing belts available in single or double sided version, in classical pitches and RPP profiles. A large range of products available from stock.

**SECTIONS:**

MXL - XL - L - H - XH - XXH - XL DD - L DD - H DD  
 STD 8M - HTB 3M - HTB 5M - HTB 8M - HTB 14M  
 RPP3 - RPP5 - RPP8 - RPP14  
 SLV3 5M - SLV3 8M - SLV3 14M - GLD2 5M - GLD2 8M - GLD2 14M  
 TTM8 - TTM14  
 RPP5 DD - RPP8 DD - RPP14 DD  
 (SLV3 8M DD - SLV3 14M DD - GLD2 8M DD - GLD2 14M DD)\*



*\*on demand*

## RUBBER OPEN-ENDED

Open-ended belts especially suitable for linear drives, accurate positioning and bidimensional drives, where the rotation has to be translated into a linear position. Available in classical and RPP profiles.

**SECTIONS:**

MXL - XL - L - H - RPP3 - RPP5 - RPP8 - RPP 14  
 SLV3 3M - SLV3 5M - SLV3 8M  
 TTM 8M - TTM 14M  
 (SLV3 14M - GLD2 5M - GLD2 14M)\*



*\*on demand*

## MEGAPOWER

Polyurethane endless timing belts manufactured using a unique thermoset moulding process.

**SECTIONS:**

MXL - XL - L\* - H\* - T2 - T2,5 - T2.5 DD  
 T5\* - T10\* - T5 DD\* - T10 DD\*  
 AT5 - AT10\*



*\*available also with FC material*

## MEGAFLEX

Polyurethane endless timing belts made of thermoplastic polyurethane, with a continuous spiral cord.

**SECTIONS:**

XL - L - H - XH - XL DD - L DD - H DD - XH DD  
 T5 - T10 - T20 - T5 DD - T10 DD - T20 DD  
 AT5 - AT10 - AT15 - AT20 - AT5 DD - AT10 DD  
 - AT15 DD - AT20 DD  
 MTD 8M - ATG10 K13  
 RPP5 - RPP8 - RPP14 - RPP5 DD - RPP8 DD  
 - RPP14 DD  
 P2



## MEGALINEAR

Open-ended timing belts made in thermoplastic polyurethane, available in both open-ended or joined versions.

**SECTIONS:**

MXL - XL - L - H - XH - T2,5 - T5\* - T10\* - T20  
 AT3 - AT5 - AT10 - AT20  
 RPP5 - RPP8 - RPP14 - RPP14 XHP  
 MTD3 - MTD5 - MTD8 - MTD14  
 STD5 - STD8 - MEGAC4T™ AT10  
 TG5 - TG10 K6 - TG10 K13 - TG20  
 ATG5 - ATG10 K6 - ATG10 K13 - ATG20 - HG  
 QST5 - QST8 - QST14  
 GW14 - GW20 - P1 - P2 - P3 - P4

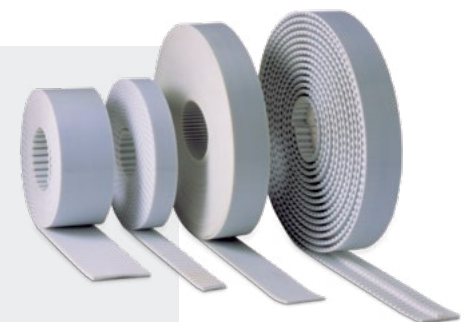

*\*available also with FC material*

# V-BELTS

## OLEOSTATIC GOLD – OLEOSTATIC – EXTRA

### OLEOSTATIC SECTIONS:

20 - 25 - 45 - 50 - 3V - 5V - 8V

### OLEOSTATIC GOLD SECTIONS:

Z - A - B - C - D - E - SPZ - SPA - SPB - SPC

### EXTRA SECTIONS:

Z - A - B - C - SPZ - SPA - SPB - SPC



## ESAFLEX

### SECTIONS:

AA - BB - CC



## XDV2

### SECTIONS:

XDV38 - XDV48 - XDV58



## LINEA GOLD

### SECTIONS:

AX - BX - CX - XPZ - XPA - XPB - XPC



## LINEA X

### SECTIONS:

XPZ - XPA - XPB - XPC



## VARISECT

### SECTIONS:

13X6 - 17X6 - 21X7 - 22X8 - 26X8 - 28X8  
- 30X10 - 32X10 - 36X12 - 37X10 - 42X13 -  
47X13 - 52X16 - 55X16 - 65X20 - 70X20



## PLURIBAND

### SECTIONS:

RA - RB - RC - RSPZ - RSPA - RSPB - RSPC  
R3V - R5V - R8V - R3VX - R5VX



## MEGAWELD

A wide selection of trapezoidal and round weldable belts made in thermoplastic polyurethane by a unique extrusion process and suitable for numerous applications.



## ACCU-LINK®

Accu-link® may be used as an emergency belt in place of V-belts in case of unexpected failure, but is also originally installed in many industrial sectors.



# FLAT BELTS

## MEGAFLAT (PU AND RUBBER)

Flat belts truly endless mandrel moulded, available with polyester, aramid or cotton reinforcements.

### MEGAFLAT POLYURETHANE SECTIONS:

P0 - P102 - P108 - P110 - P120 - P155  
S108 - S110 - S120 - S155

### MEGAFLAT RUBBER SECTIONS:

T75 - T108 - T110 - T120 - T150 - T155 - T200

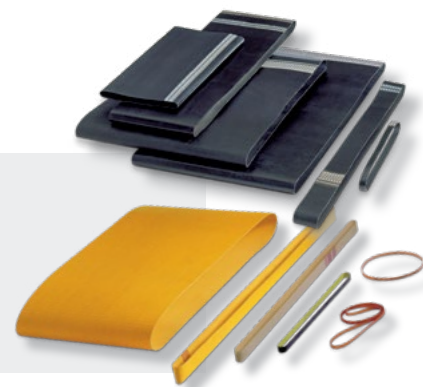

# MULTI-RIB BELTS

## PV BELTS

Endless rubber belts with longitudinal V-shaped grooves providing high flexibility and great power performance.

### SECTIONS:

PH - PJ - PK - PL - PM

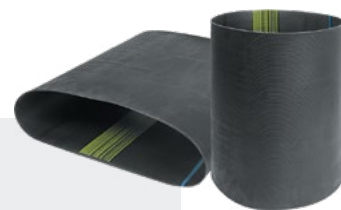

## ROLLPOWER™

The new elastic rubber ribbed belt designed to outperform in roller conveyor applications.

### SECTIONS:

PJ

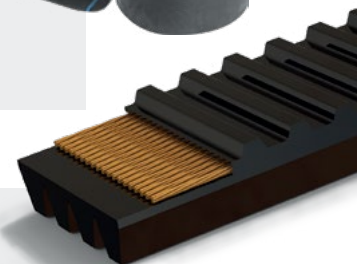

## MEGARIB

Ribbed belts manufactured using a thermoset compound with polyester or polyamide high tension cord.

### SECTIONS:

PJ - PH - PTB2



# METAL DRIVE COMPONENTS

Megadyne stocks and supplies an extensive range of pulleys and accessories like timing bars, taper bushes, flanges, clamping plates... to offer a complete drive transmission system.



# SPECIAL & FABRICATED BELTS

## COVERS AND MODIFICATIONS

Megadyne can fully customise its belts with a variety of covers - in polyurethane, rubber elastomer, foam, PVC - and the following special modifications:

- CLEATS
- FALSE TEETH
- CUSTOM SHAPES
- GRINDING
- NOTCHING/KNIFE CUT
- FABRIC ADDED TO THE TOOTH SIDE OF BELT
- HOLES/PERFORATIONS/GROOVES /VACUUM COUNTERSINKS
- POCKETS
- SLOTS
- SAW TOOTH



## PPJ SYSTEM

Very fast belt replacement system to join belts directly on the machine.

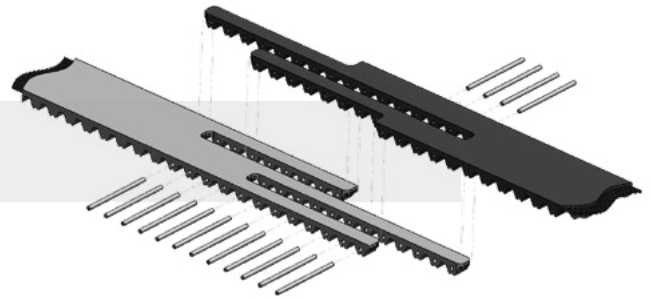

## CERTIFICATIONS



All Megadyne polyurethane power transmission belts comply with ISO 14001, ISO 9001 and European RoHS Directive. The belts are made with raw materials in compliance with REACH standards, meaning that all belts, pulleys, toothed bars, couplings blocking units and other items supplied by Megadyne do not contain one (or several) of the SVHC in Candidate List above a concentration of 0.1% w/w.

All Megadyne rubber power transmission belts are made in accordance with the Quality Management System Standard: ISO 9001 and ISO 14001. These certificates are valid for the following field of application: design, manufacture and sale of power transmission belts. Marketing of transmission and transport elements (pulleys, tensiometers).

## MEMBERSHIPS



# Discover Your Local Contacts

The local partner of choice  
for sustainable power transmission belting solutions  
around the globe.



Scan the QR code  
and find your local  
contact

**General contact information:**

**Megadyne**

Via Trieste, 16  
Via S. Lucia 114 - 10075 Mathi (Torino)  
Italy

